

# Manfrotto nord

ART.  
116MK3

VERSIONE:008

DEL:1996-07-11

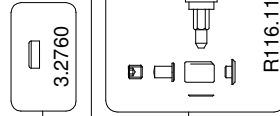
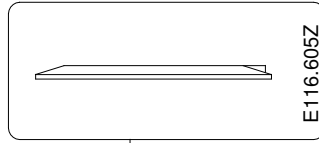
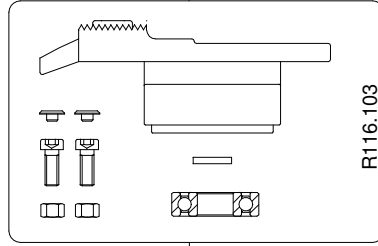
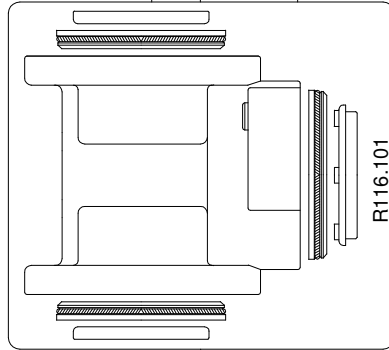
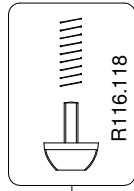
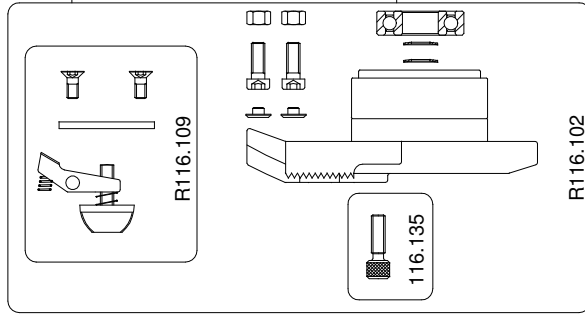
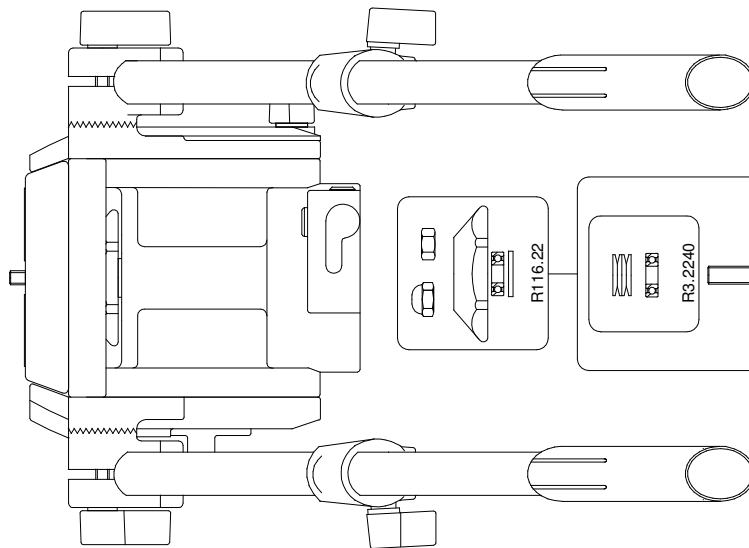

3.2760

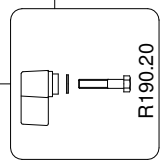
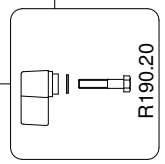
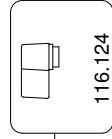
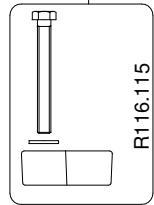
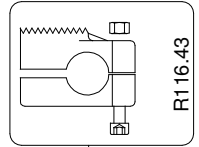
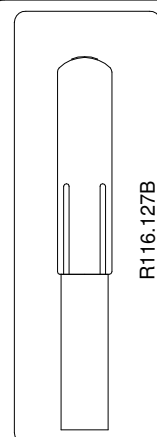
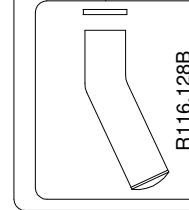
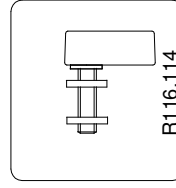
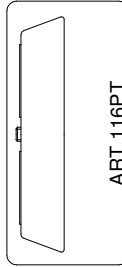
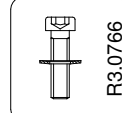
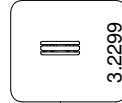
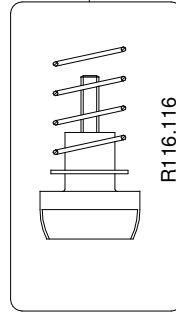
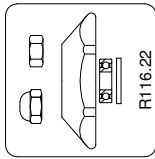
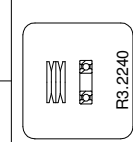
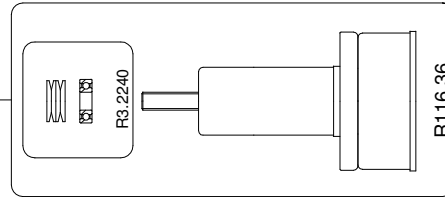

R116.90

FOR FLUID GREASE ORDER COD. R116.23

E116.509Z